

VIENNA

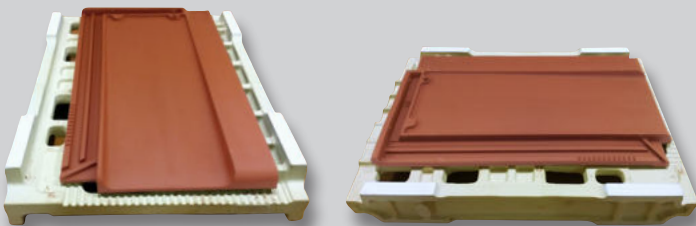



CERAMIC ROOF SOLUTIONS



Single H fire supports that allow the tiles to be fired individually at high temperatures, obtaining perfect definition.



PERFECTION IS TO REACH THE TOP. La Escandella stands once again by the latest technology, heavily investing in a new production line designed to optimize the finish of its products and creating a Premium product range. Discover the new H-Selection line, made for excellence.

H-Selection is the result of applying modern manufacturing processes in H-Cassette to a selection of our products, endowing them with numerous functional and aesthetic advantages and benefits.



Excellent flatness

Individual curing of each tile thanks to support in H. Excellent flatness with no contact points.



High definition on each piece

It provides a perfect definition on each piece, made with gypsum moulds, providing a much finer texture.



Low absorption

Higher resistance to ice and mould formation.



Lifetime warranty

Our 100 years of warranty ensure your peace of mind and demonstrate the quality of our manufacturing process.

VIENNA

Ample longitudinal overlapping (80mm)

Avoids cutting the tiles, therefore reducing time and installation costs.

Double interlocking

The double interlocking -horizontal and vertical- allows the roof to be more watertight, ensuring its impermeability.

Higher resistance

The clay composition together with the perfect pressing allows flexion higher than the required while only weighing 3.6 kg.

Excellent flatness

H-Cassette manufacturing provides a perfect finish to each product.

Lower absorption (<5%)

High quality clay together with high firing temperature mean higher resistance to ice and mildew.

High definition on each piece

The gypsum moulds provides a perfect finish, obtaining a smoother texture, no contact points nor creases.

Cost reduction

Its large format (11.5 units/m²) and strapping every 6 units, as well as its packaging on pallets of 288 units, reduce installation costs

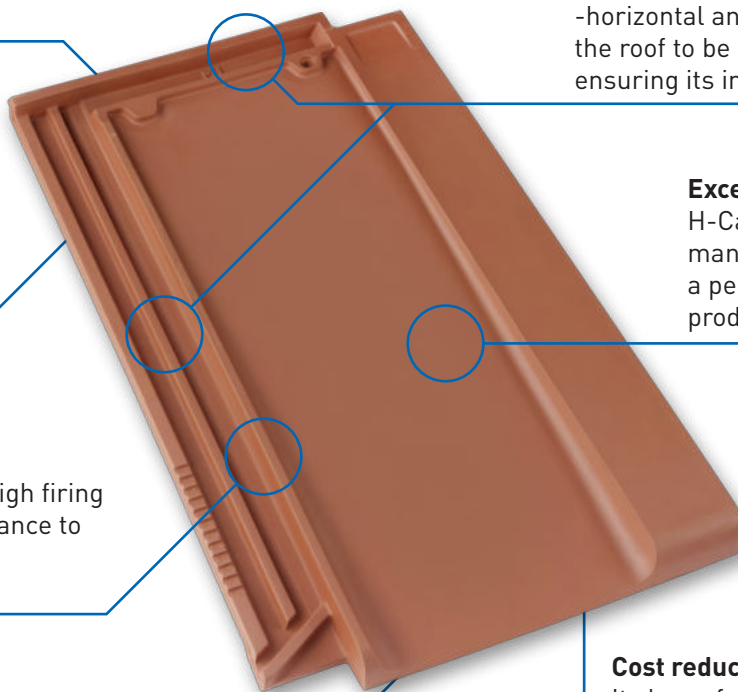

TECHNICAL CHARACTERISTICS

Flexural Strength test (EN 538)	Resistance > 1200N
Water Impermeability (EN 539-1)	Complies with level 1
Frost Resistance (EN 539-2)	Complies 150 cycles
Geometric Characteristics (EN 1024)	Flatness / Straightness ≤ 1,5%

Dimensions*	A: 460mm; B: 255mm; C: 30mm A: 18.11"; B: 10.04"; C: 1.18"
Pieces /m ² - P./sq.	11.5 - 105
Weight piece	3.6 kg / 7.9 lbs
Longitudinal fit **	396mm (+5mm; -75mm) / 15.6" (+0.19"; -2.95")
Transversal fit **	214mm (± 1mm) / 8.42" (±0.04")
Units per pallet	288
Weight per pallet	1,037 kg (2,286.2 lbs)
Laying	Straight bond

*The tile dimensions indicated in this chart allow a tolerance of approximately ±.2%
**Theoretic value: this should be re-calculated on site with the tiles that are to be used.



According to European standard



Test of frost resistance



Impermeability



Flexural strength test



Geometric characteristics





La Escandella

100 YEARS

GUARANTEE

PERFECTION AT THE
FOREFRONT OF DESIGN

FINISHES



TVP
SLATE

TIP



- Colour variations within one batch, affecting the whole of that batch and produced specifically for aesthetic reasons, are permissible.
- For tiles of one single colour, variations in color due to the ceramic process itself are accepted.
- We advise not to mix tiles from different batches on the same roof section.
- We recommend not to stack more than 2 pallets.

Inspiring Colours



The Galaxy finished is a metallic color that can have a diamond effect, like a brightness variation of each tile according to the sun exposure.

TECHNICAL ADVANTAGES

1 LOWER ABSORPTION AND HIGHER FROST RESISTANCE

- Water absorption on Klinker H-Cassette tiles is lower than 5%.
- Higher resistance to ice and mildew.



2 OVERLAPPING

- 80mm of longitudinal fit (between 11,5 and 15 pieces per sqm).
- Adaptable for re-roofing on already laid battens (reburishments)

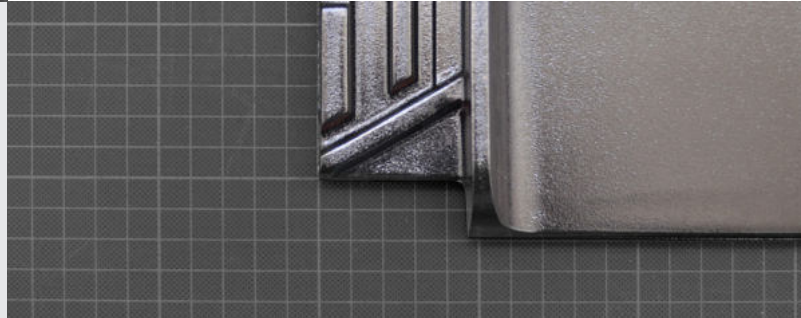

3 INTERLOCKING

- 45mm interlocking > Large drainage rib.
- *Bigger watertightness.*



4 TOP INTERLOCKING

- Top interlocking sealed.
- *Bigger wattertightness: tiles can be fixed straight on due to the interlocking system.*



5 NAIL HOLE

- Pre-hole (easy to be nailed)
- *Less tile breakages when nailing.*

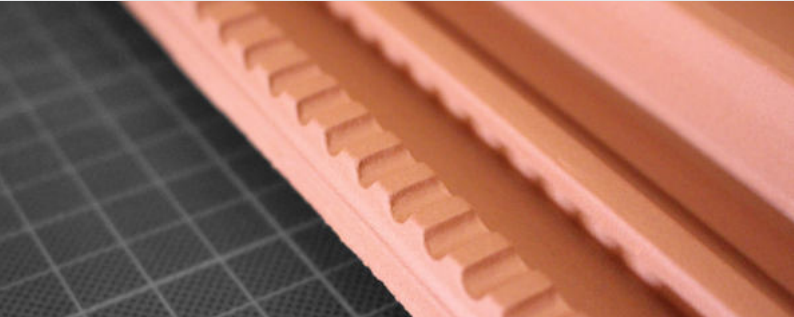

6 HOOK ATTACHMENT

- Sawtooth.
- *Easy hook fixing.*

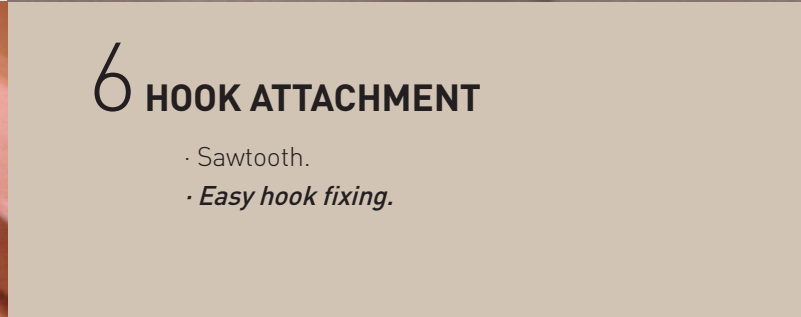



BEAUTY & FUNCIONALITY
ALL IN ONE

10-7

LAI D METHOD

TIP

Widthwise or lengthwise laid suggested in the technical catalogues are theoretical. The roofer must calculate the real widthwise or lengthwise laid of the tiles to be installed according to the methods defined in the rules in force in our installation manual.

Tiles are manufactured with natural components and fired at high temperature which generates small dimensional variations.

Download the
**INSTALLATION
MANUAL**

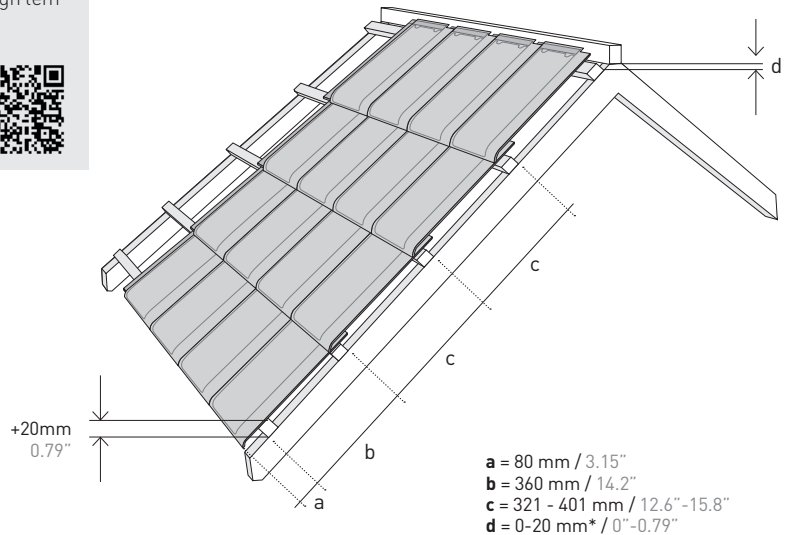

* First course batten should be 20 mm (0.79") higher than all succeeding course battens to provide a vertical alignment and to assure a symmetrical installation.

STRAIGHT BOND

1. The starter course will begin with the **Q116*K** right side course, continuing with the full tiles to complete the eave. The tiles structuring the eave will have to overlap the side course and fit together one to another. We will finish the eave with the **Q115*K** left side course.
2. The second course will be started again installing the **Q116*K** right side course and doing the same as in step 1.
3. This exposure is continued through each successive course till the ridge.

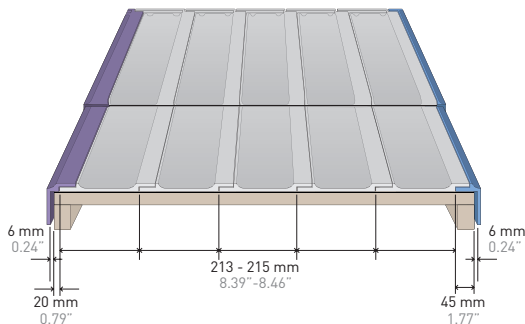

- **Q115*K** Innova/Vienna left side course klinker
- **Q116*K** Innova/Vienna right side course klinker

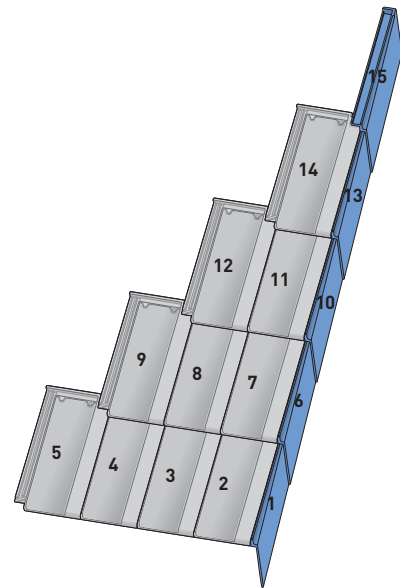

NOTE: A control line between 3 and 5 rows of tiles (maximum) is recommended.

INSTALLATION DETAILS

RIDGE

-Ridge tiles must be installed lap facing away from the prevailing winds, in order to assure water tightness.

-Field tiles at top course should be secured directly either into the deck or top batten with stainless ring screw nails or similar.

-All ridges and hips shall be covered with self adhesive Alu-Roll (CAM01, CAMF1, CAM09, CAMF9) or similar approved breathable waterproof underlayment. Underlayment should be secured over the ridge nailer with non-corrosive roofing nails.

-Apply ridge tiles with a minimum overlapping of 5 cm (2") throughout the ridgeline facing away from the prevailing wind-driven rain.



HIP

-Hip tiles must be installed in the same way as in the ridge.

-Field tiles must be miter cut parallel to the hip line and secured.

-All ridges and hips shall be covered with self adhesive Alu-Roll (CAM01, CAMF1, CAM09, CAMF9) or similar approved breathable waterproof underlayment.

- Air should be able to flow through the ridge and hip area. Be sure not to close these off with mortar or similar. Closing them off could result in cracks, peeling off., in freezing and thawing cycles.

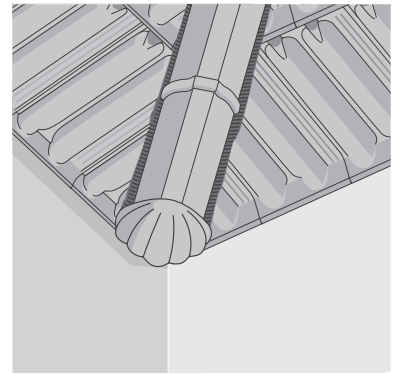

VALLEY

-Both Valley and eave line channel are particularly vulnerable to water migration and leakage. Valleys should have a clear and unobstructed pathway for quick water drainage.

-Install valley battens on each side of the valley crease. Alu-roll Valley (CAM18), or similar approved adhered waterproof valley underlayment, shall be laid vertically up all valleys in addition to other required underlayment that should be fixed by using glue, resin or similar.

-Where valley intersects with ridge line, apply Alu-roll Valley (CAM18), or similar approved underlayment, which should be covered by the ridge tile. Valley should be extended along the eaves to overhang the fascia board by 5cm (2") or over the gutter.

-Tiles should be laid parallel to the valley line, at same relative angle and should overhang the valley battens by at least 10 cm (4").

-Tiles at each side of the valley crease should be laid to provide a minimum 15 cm (6") width gap (tiles should held back minimum 7.5 cm (3") from the center of the valley each way).

-Valley tiles must be secured.

-Proper Valley flashing installation is required to ensure water tightness in order to avoid cracks, peeling off,...

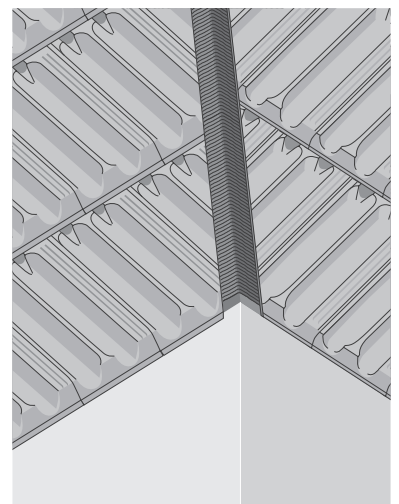

ACCESSORIES

Q02*K | Round ridge / Hip klinker

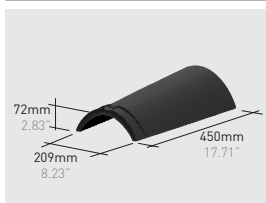

3,400 gr / 7.49 lbs 2.5 u./lm

Q90*K | Atica ridge 120° klinker

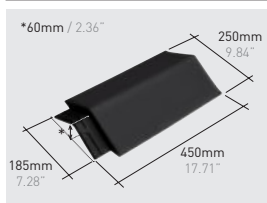

3,400 gr / 7.49 lbs 2.5 u./lm

Q120*K | Angular ridge klinker

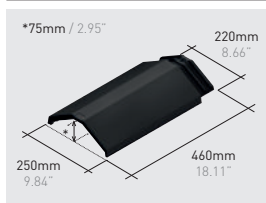

3,500 gr / 7.71 lbs 2.5 u./lm

Q145*K | Ridge 45° klinker

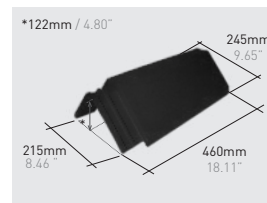

3,850 gr / 8.49 lbs 2.5 u./lm

As wedge must be used **Q120*K**

Q04*K | Round ridge end / Hip starter klinker

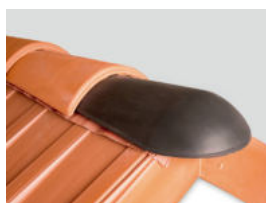
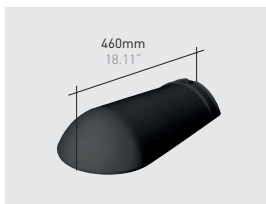

3,300 gr / 7.28 lbs

Q109*K | Atica 120° hip / end ridge klinker

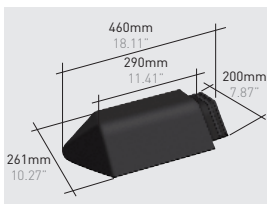

2,900 gr / 6.39 lbs

Q122*K | Angular hip / end ridge klinker

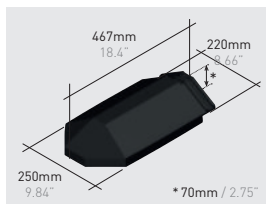

3,400 gr / 7.49 lbs

Q83*K | End cap round ridge klinker

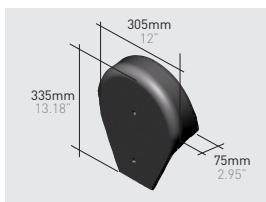

2,500 gr / 5.51 lbs

Q124*K | Angular end cap klinker

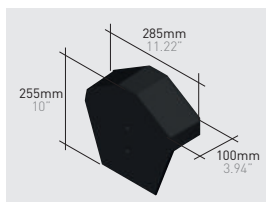

2,180 gr / 4.8 lbs

Q147*K | End cap 45° klinker

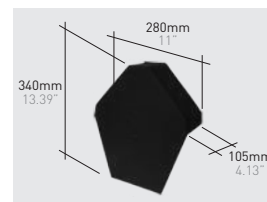

2,700 gr / 5.95 lbs

Q44*K | Round 3 way ridge klinker



4,600 gr / 10.14 lbs
with **Q02*K**

Q45*K | Round 4 way ridge klinker



4,100 gr / 9.04 lbs
with **Q02*K**

Q55*K | Round 3 way ridge female klinker

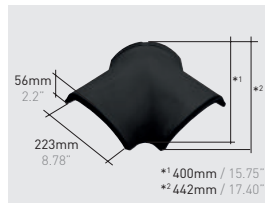

4,100 gr / 9.04 lbs
with **Q02*K**

Q146*K | 45° 3 way ridge klinker

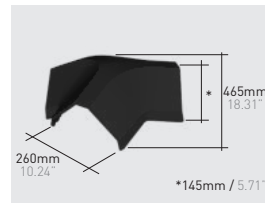

5.000 gr / 11 lbs
with **Q145*K**

Q111*K | Atica 120° 3 way ridge klinker

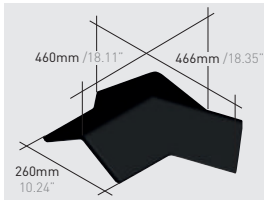

5,100 gr / 11.24 lbs
with **Q120*K**

Q123*K | Angular 3 way ridge klinker

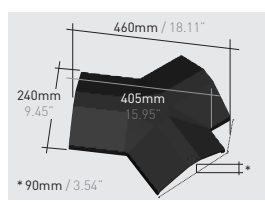

3,920 gr / 8.64 lbs
with **Q120*K**

Q115*K | Innova/Vienna left side course klinker

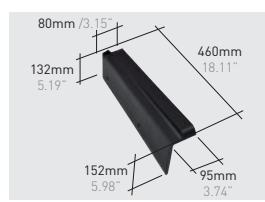

2,500 gr / 5.51 lbs

Q116*K | Innova/Vienna right side course klinker

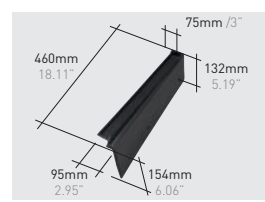

2,500 gr / 5.51 lbs

Q117*K | Innova/Vienna ventilation roof tile klinker

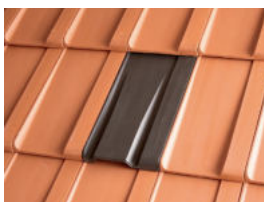
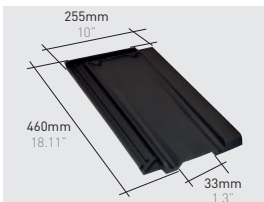

3,550 gr / 7.83 lbs

Q118*K | Innova/Vienna chimney roof tile klinker

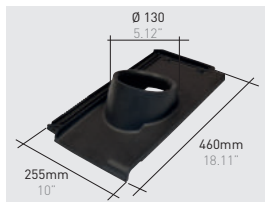

3,550 gr / 7.82 lbs

Q121*K | Innova/Vienna Chimney klinker

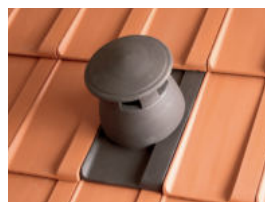

2,500 gr / 5.51 lbs
with **Q118*K**

ROOF ACCESSORIES FOR VENTILATED ROOFS

La Escandella offers a wide range of non-ceramic accessories which help finish off any type of roof. From waterproofing to ventilation, fixing and batten installing, safety implementation and multiple profiles can be found here. [Ask for wider range in last Price List].

CAM01 / CAMF1
Alu-Roll With Micro Cut

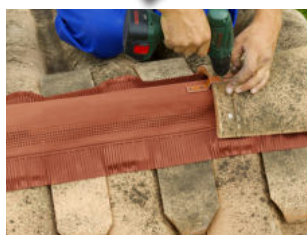

Width: Several sizes
Colours: Red, paja, brown, black.

CAM08 / CAMF8
Alu-Flex

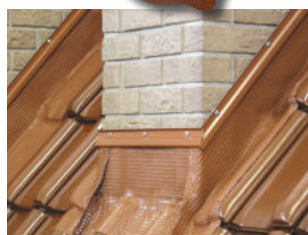
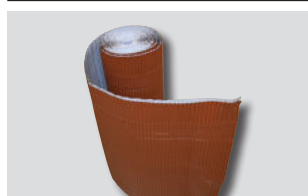

Width: Several sizes
Colours: Red, paja, brown, black.

CAM09 / CAMF9
Alu-Roll Membrane

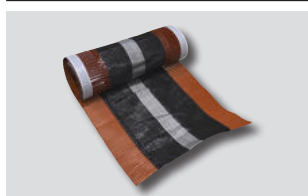

Width: Several sizes
Colours: Red, brown, black.

CAM18
Alu-Valley Tape

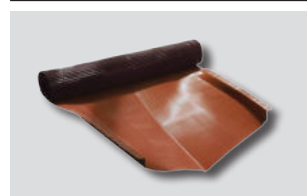

Width: 50 mm / 1.96"
Colours: Red, black, brown.

CAM65 / CAM21 / CAM52 / CAM53
Waterproof membrane



Dimensions: 1,5 m x 50 m / 1.64 yd x 54.68 yd
Weight: several weights.

CAM27NEW / CAM10 / CAM123
Ridge Tile Hook



Colours: Red, brown, black.

CAM05 / CAM010 / CAM51
Ridge Batten Bracket



Dimensions: Several sizes.

CAM14
Eaves Ventilation Comb



Dimensions: 6cm x 1m / 2.36" x 39.37"
Colours: Red, black.

MORE INFO
ON THE
WEBSITE



CAM64
Metal clip clipped with a bumper



CAM26
Universal clip for roof tiles with lace

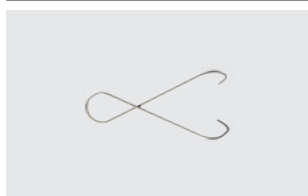

CAM59
Metal hook/clip for wood batten

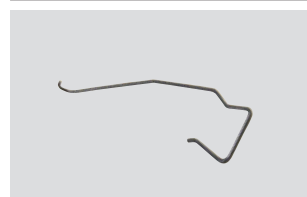

CAM62
Eave hook/clip for roof tiles with lace



TECHNICAL INFORMATION

SLOPES / PITCHES

The minimum pitch standard recommendations should always be followed (see values in the referral table). On all pitches below the standard recommended minimums, or in regions where ice dams may occur, a waterproof underlayment on the entire deck **MUST** be applied. Most problems with water-shedding roof installations occur from water that migrates through the joints of the tiles through capillary action, wind-driven rain, and runoff or ice damming. Because of this possibility, the underlayment is critical to the success of the roof.

	WITHOUT UNDERLAYMENT				WITH UNDERLAYMENT			
	ZONE 1	ZONE 2	ZONE 3		ZONE 1	ZONE 2	ZONE 3	
Protected	25% / 14°	25% / 14°	27% / 15,5°	Hip < 6,5 m	23% / 13°	23% / 13°	25% / 14°	Protected
Normal	25% / 14°	27% / 15,5°	30% / 17°		23% / 13°	25% / 14°	28% / 16°	Normal
Exposed	33% / 18,5°	37% / 20,5°	40% / 22°		31% / 17,5°	35% / 19,5°	38% / 21°	Exposed
Protected	26% / 15°	25% / 14°	30% / 17°	Hip 6,5 m - 9,5 m	24% / 13,5°	26% / 14,5°	30% / 17°	Protected
Normal	28% / 16°	32% / 18°	36% / 20°		26% / 14,5°	28% / 16°	32% / 18°	Normal
Exposed	35% / 19,5°	39% / 21,5°	43% / 23,5°		33% / 18,5°	37% / 20,5°	42% / 23°	Exposed
Protected	27% / 15,5°	30% / 17°	35% / 19,5°	Hip 9,5 m - 12 m	25% / 14°	27% / 15,5°	32% / 18°	Protected
Normal	32% / 18°	35% / 19,5°	40% / 22°		30% / 17°	33% / 18,5°	37% / 20,5°	Normal
Exposed	42% / 23°	45% / 24,5°	50% / 26,5°		40% / 22°	43% / 23,5°	47% / 25°	Exposed

PROTECTED LOCATIONS: hollow area which is surrounded by hills that protect the hollow from the winds in all directions..

NORMAL LOCATIONS:: Flat area, plateau with minimal elevation changes.

EXPOSED LOCATIONS: Places open to strong winds, coastal areas (up to 5 km / 3 miles from the shoreline), islands or narrow peninsulas, estuaries or closed bays, narrow valleys, isolated mountains, mountain passes and earthquake zones.

Note: For hips MORE than 12m long (39.4'), a waterproof underlayment on the entire roof deck **MUST** be applied and the ventilation underneath must be reinforced (check with the manufacturer).

FIXATION

The slope of a roof determines the level of fixation of the tiles required. The fixation of the tiles may be necessary to prevent the sliding of the roof tiles or to prevent their lifting by the effect of the air. **In eaves, right and left side course, lines of ridge, valleys, encounters with vertical walls and other singular points, all the pieces will be fixed.** For all other parts, the level of fixation will depend on the pitch.

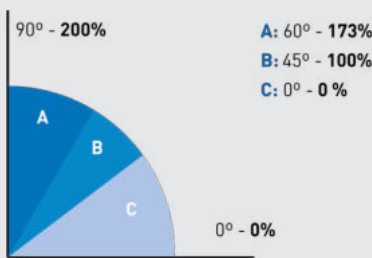

A: Every roof tile should be securely fastened by nailed, screwed, clipped...

B: Roof tiles will be fixed at least once every two or three, depending on the exposure of the roof and the height of the building.

C: The roof tiles shall be fixed at least in the proportion of one in five from a horizontal line, initiating fixation by rows alternately and regularly on the battens.

In case of high wind exposure, all roof tiles must be fixed.

VENTILATION

Ventilation is one of key elements to assure a good hygrothermal behavior of the roof and preservation of the roof structure. The key to a good and well preserved roof is a good ventilated roof. Proper installation of Ventilation tiles combined with ventilated roof can result in energy savings, in a more energy efficient home.

Air should be able to flow through the eave and ridge; be sure not to close these off with cement, mortar or similar. Eave and ridge areas should be protected to help minimize the access of birds and vermin infiltration.

A free flowing ventilation area must be provided through the roof deck. This ventilation should be evenly distributed throughout the roof space to eliminate any dead air space.

La Escandella recommends a minimum of ventilation tile (Q117*K) for every 7 m² (1.32 vent tiles per 100 sq ft.) and with a minimum of 2 ventilation tiles per roof surface, installed on the upper part of the roof.

Using a proper ventilation system is the best way to avoid moisture in a roof, that could cause peeling, cracking and other defects on the tile.

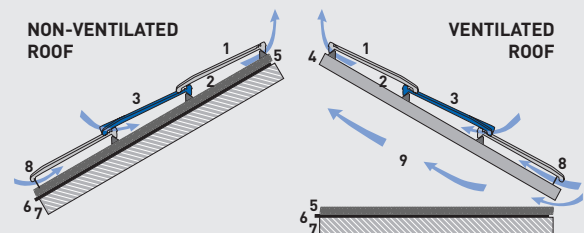

1. Roof tile
2. Micro-ventilation void
3. Ventilation roof tile
4. Rafter
5. Heat insulation underlayment
6. Waterproof underlayment material
7. Frame
8. Eaves ventilation comb / bird stop
9. Attic

La Escandella

ROOFING THE WORLD

Una marca
EDILIAN GROUP



www.laescandella.com



CATALOGUE
LATEST
VERSION



Colour Shall be Harmonized but clay tiles are a natural product and some shade variations between individual pieces enhance their beauty and should be expected. All Tiles should be blended regardless of the number of colours supplied. Colours of the tiles shown in this catalogue can not faithfully reflect the colours of the ceramic tiles.

On their products, La Escandella has right to make changes in dimensions, fittings, weight & units per pallet, without previous notice. For more information, please contact your Sales Representative or our Customer Care Service.

This catalogue, printed in January 2024, replace the existing ones.